

Current Sensor

Product Series: SHK-VBS-T

Part number: SHK-VBS-TU-1000-S3

Version: Ver 1.2

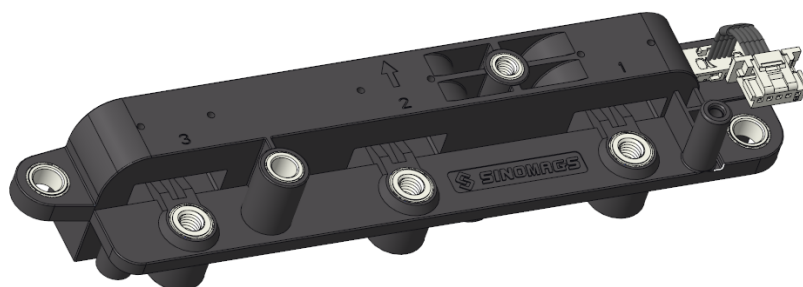

CONTENT

1. Description.....	2
2. Electrical data.....	3
3. Product definition statement	4
4. Electrical circuit diagram	5
5. Dimension & Pin definitions	6

1. Description

The SHK-VBS-TU-S3 current sensor is based on Hall and open-loop design. It is suitable for DC, AC pulsed and any kind of irregular current measurement under the isolated conditions.

Typical applications

- AC Variable speed drives
- Inverter
- Electric welder power supply
- Switched model power supplies (SMPS)

General parameter

Parameter	Symbol	Unit	Value
Working temperature	T_a	°C	-40 ~ 125
Storage temperature	T_{stg}	°C	-40 ~ 125
Mass	m	g	144

Absolute maximum rating

Parameter	Symbol	Unit	Value
Supply voltage	Vcc	V	-0.5 ~ 8 (Not operating)
			6.5
Electrostatic discharge voltage	$U_{ESD\ HBM}$	kV	8

Remark: the unrecoverable damage may occur when the product works on the conditions over the absolute maximum ratings. Long-time working on the absolute maximum ratings may cause the degradation on performance and reliability.

Isolation parameter

Parameter	Symbol	Unit	Value	Comment
Insulation voltage	U_d	kV	2.5	RMS voltage for AC test 50Hz-1 min
Insulation resistance	R_{INS}	MΩ	500	DC 500V, ISO 16750
Clearance distance (pri. -sec)	d_{Cl}	mm	5.1	Shortest distance through air
Creepage distance (pri. -sec)	d_{Cp}	mm	5.1	Shortest path along device body
Comparative tracking index	CTI		PLC 3	
Case material			V0 according to UL 94	

2. Electrical data

Condition : $T_a = 25^\circ\text{C}$, $V_{CC} = 5.0\text{ V}$

Parameter	Symbol	Unit	Min	Typ	Max	Comment
Primary current measuring range	I_{PM}	A	-1000		1000	SHK-VBS-TU-1000-S3
Supply voltage	V_{CC}	V	4.75	5	5.25	All
Current consumption	I_{CC}	mA		39	60	@ $V_{CC} = 5.0\text{ V}$
Output voltage	V_{OUT}	V	$(V_{CC}/5) \times (V_{off} + G \times I_{PM})$			@ $T_a = 25^\circ\text{C}$
Quiescent voltage	V_{off}	V		2.5		@ $T_a = 25^\circ\text{C}$, $V_{CC} = 5.0\text{ V}$
Sensitivity	G	mV/A		2.00		SHK-VBS-TU-1000-S3
Load resistance	R_L	k Ω	10			
Ratiometricity error	ϵ_r	%		± 0.5		@ $4.75\text{V} \leq V_{CC} \leq 5.25\text{V}$
Sensitivity error	ϵ_G	%		± 1		@ $T_a = 25^\circ\text{C}$, After T° Cycles
Electrical offset voltage error	V_{OE}	mV		± 4.0		@ $T_a = 25^\circ\text{C}$, $V_{CC} = 5.0\text{ V}$
Magnetic offset voltage error	V_{OM}	mV	-7.5		7.5	@ $T_a = 25^\circ\text{C}$, $V_{CC} = 5.0\text{ V}$
Ave. Temp. coefficient of V_{OE}	TCV_{OEAV}	mV/ $^\circ\text{C}$	-0.08		0.08	@ $-40^\circ\text{C} < T_a < 125^\circ\text{C}$
Ave. Temp. coefficient of S	TCS_{AV}	%/ $^\circ\text{C}$	-0.03	± 0.01	0.03	@ $-40^\circ\text{C} < T_a < 125^\circ\text{C}$
Linearity error	ϵ_L	% I_P	-1		1	of Full range, $-1000\text{ A} \leq I_P \leq 1000\text{ A}$ @ $T_a = 25^\circ\text{C}$, $V_{CC} = 5.0\text{ V}$
Response time	T_r	μs		2	6	@ 90% of I_{PM}
Frequency bandwidth (-3 dB)	BW	kHz	40			No RC circuit
Output voltage noise	V_{no}	mVpp		20		@ DC ~ 10 kHz

Total error(mV) for $\leq 1000A$

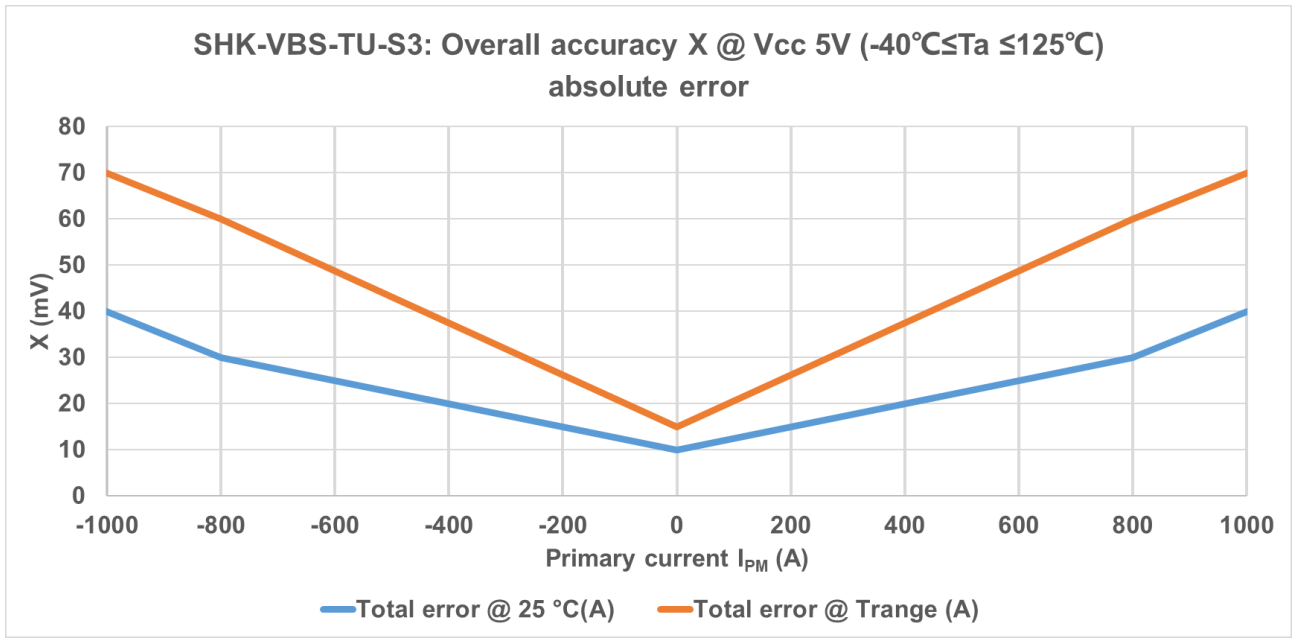

Overall accuracy X specification(mV)				
I _{PM} (A)	@Ta=25°C, VCC=5.0V		@-40°C ≤ Ta ≤ 125°C, VCC=5.0V	
1000	40	±2%	70	±3.5%
800	30	±1.5%	60	±3%
0	10	±0.5%	15	±0.75%
-800	30	±1.5%	60	±3%
-1000	40	±2%	70	±3.5%

3. Product definition statement

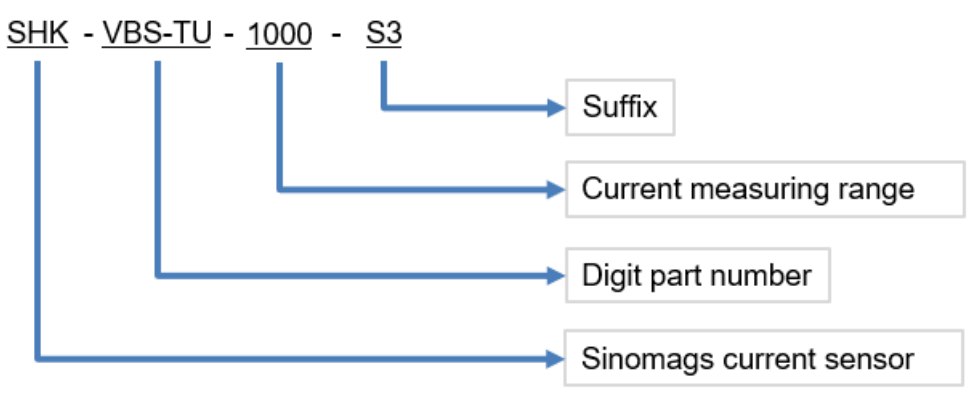

4. Electrical circuit diagram

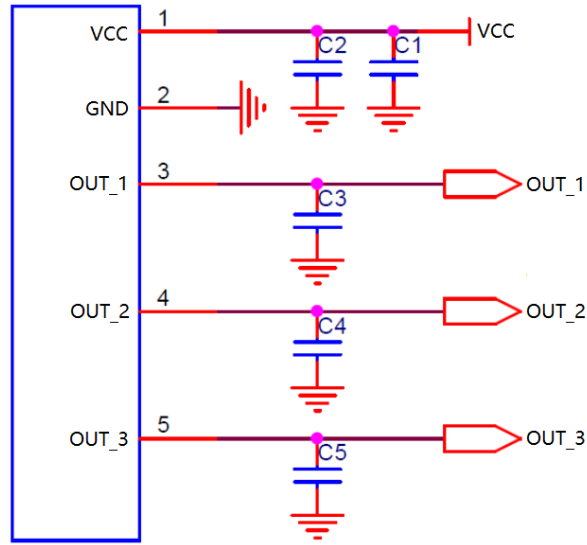

Remarks:

Capacitor recommended specification:

C1	1uF
C2	100nF
C3、C4、C5	1nf

5. Dimension & Pin definitions

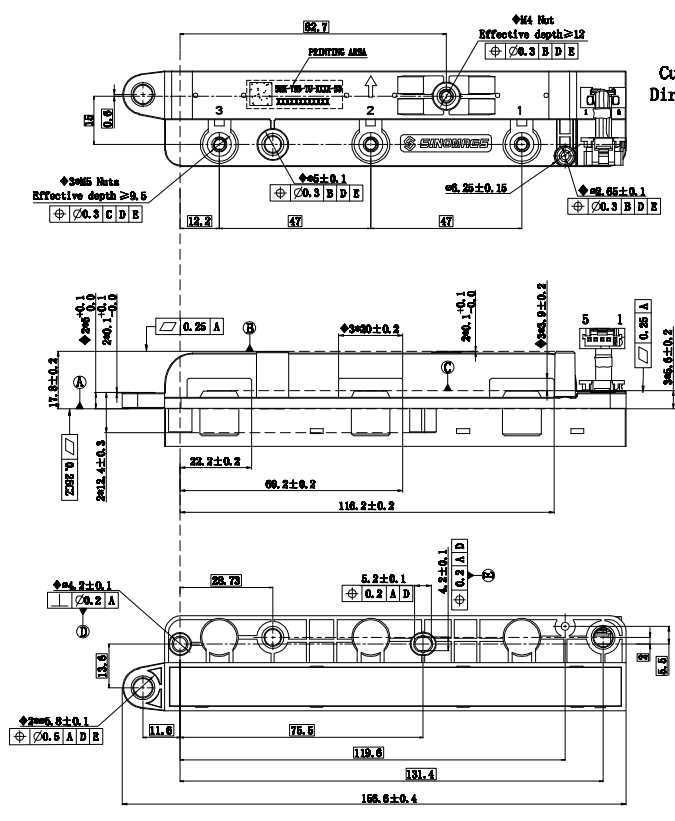

Current Direction ↑

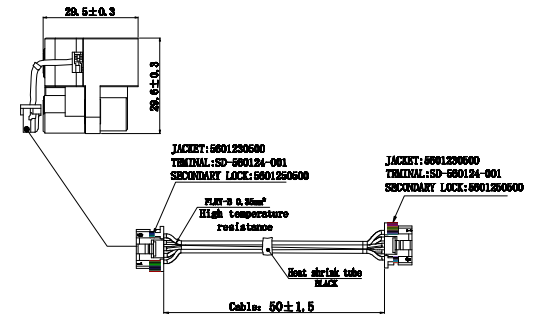

Terminals:

Pin 1	Vcc(+5V)
Pin 2	GND
Pin 3	Vout-1
Pin 4	Vout-2
Pin 5	Vout-3

Material : Fit UL94V-0 & RoHS requirements ;
General tolerance : ±0.5
Unit : mm

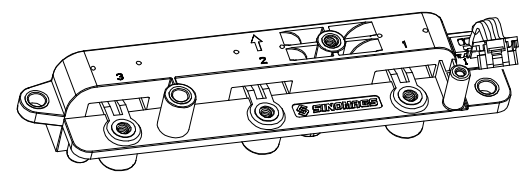
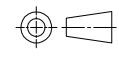

3D VIEW