

Current Sensor

Product Series: SHK-VBS-T

Part number: SHK-VBS-A3-800-S2
SHK-VBS-A3-1000-S2
SHK-VBS-A3-1100-S2

Version: Ver 1.2

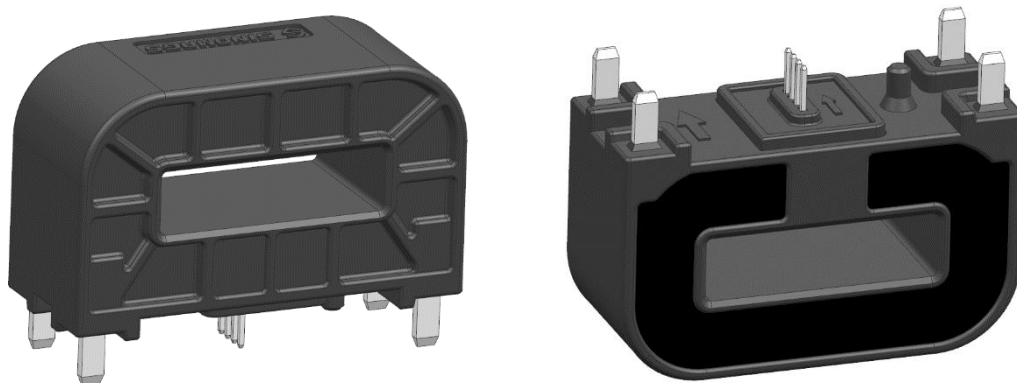

CONTENT

1.	Description	2
2.	Electrical data	3
3.	Dimension & Pin definitions.....	5

1. Description

The SHK-VBS-A3-S2 current sensor is based on Hall and open-loop design. It is suitable for DC, AC pulsed and any kind of irregular current measurement under the isolated conditions.

Typical applications

- AC Variable speed drives
- Electric welder power supply
- Inverter
- Switched model power supplies (SMPS)

General parameter

Parameter	Symbol	Unit	Value
Working temperature	T_a	°C	-40 ~ 125
Storage temperature	T_{stg}	°C	-40 ~ 125
Mass	m	g	30

Absolute maximum rating

Parameter	Symbol	Unit	Value
Supply voltage	Vcc	V	-0.5 ~ 8 (Not operating)
			6.5
Electrostatic discharge voltage	$U_{ESD\ HBM}$	kV	4

Remark: the unrecoverable damage may occur when the product works on the conditions over the absolute maximum ratings. Long-time working on the absolute maximum ratings may cause the degradation on performance and reliability.

Isolation parameter

Parameter	Symbol	Unit	Value	Comment
Insulation voltage	U_d	kV	2	RMS voltage for AC test 50Hz-1 min
Clearance distance (pri. -sec)	d_{Cl}	mm	12	Shortest distance through air
Creepage distance (pri. -sec)	d_{Cp}	mm	12	Shortest path along device body
Comparative tracking index	CTI		PLC 3	
Case material			V0 according to UL 94	

2. Electrical data

Condition : $T_a = 25^\circ\text{C}$, $V_{CC} = 5.0\text{ V}$

Parameter	Symbol	Unit	Min	Typ	Max	Comment
Primary current measuring range	I_{PM}	A	-800		800	SHK-VBS-A3-800-S2
			-1000		1000	SHK-VBS-A3-1000-S2
			-1200		1200	SHK-VBS-A3-1200-S2
Supply voltage	V_{CC}	V	4.75	5	5.25	All
Current consumption	I_{CC}	mA		12	18	@ $V_{CC} = 5.0\text{ V}$
Output voltage	V_{OUT}	V	$(V_{CC}/5) \times (V_{off} + G \times I_P)$			@ $T_a = 25^\circ\text{C}$
Quiescent voltage	V_{off}	V		2.5		@ $T_a = 25^\circ\text{C}$, $V_{CC} = 5.0\text{ V}$
Sensitivity	G	mV/A		2.5		SHK-VBS-A3-800-S2
				2		SHK-VBS-A3-1000-S2
				1.67		SHK-VBS-A3-1200-S2
Load resistance	R_L	k Ω	10			
Ratiometricity error	ϵ_r	%		± 1		@ $4.75\text{ V} \leq V_{CC} \leq 5.25\text{ V}$
Sensitivity error	ϵ_G	%		± 1.5		@ $T_a = 25^\circ\text{C}$, $V_{CC} = 5.0\text{ V}$
Electrical offset voltage error	V_{OE}	mV		± 2.0		@ $T_a = 25^\circ\text{C}$, $V_{CC} = 5.0\text{ V}$
Magnetic offset voltage error	V_{OM}	mV		± 4.0		@ $T_a = 25^\circ\text{C}$, $V_{CC} = 5.0\text{ V}$, after $\pm I_{PM}$
Ave. Temp. coefficient of V_{OE}	TCV_{OEAV}	mV/ $^\circ\text{C}$		± 0.05		@ $-40^\circ\text{C} \leq T_a \leq 125^\circ\text{C}$
Ave. Temp. coefficient of S	TCS_{AV}	%/ $^\circ\text{C}$		± 0.03		@ $-40^\circ\text{C} \leq T_a \leq 125^\circ\text{C}$
Linearity error	ϵ_L	% I_P	-1		1	% of Full range, $-1000\text{ A} < I_P < 1000\text{ A}$
			-1.75		1.75	% of Full range, $1000\text{ A} < I_P < 1200\text{ A}$
Response time	T_r	μs		2	6	@ 90% of I_{PM}
Frequency bandwidth (-3 dB)	BW	kHz	40			No RC circuit

Output voltage noise	V_{no}	mVpp	20	@ DC ~ 10 kHz
----------------------	----------	------	----	---------------

SHK-VBS-A3-S2: Overall accuracy X
@ $V_{CC} 5V (-40^{\circ}C \leq T_a \leq 125^{\circ}C)$
absolute error

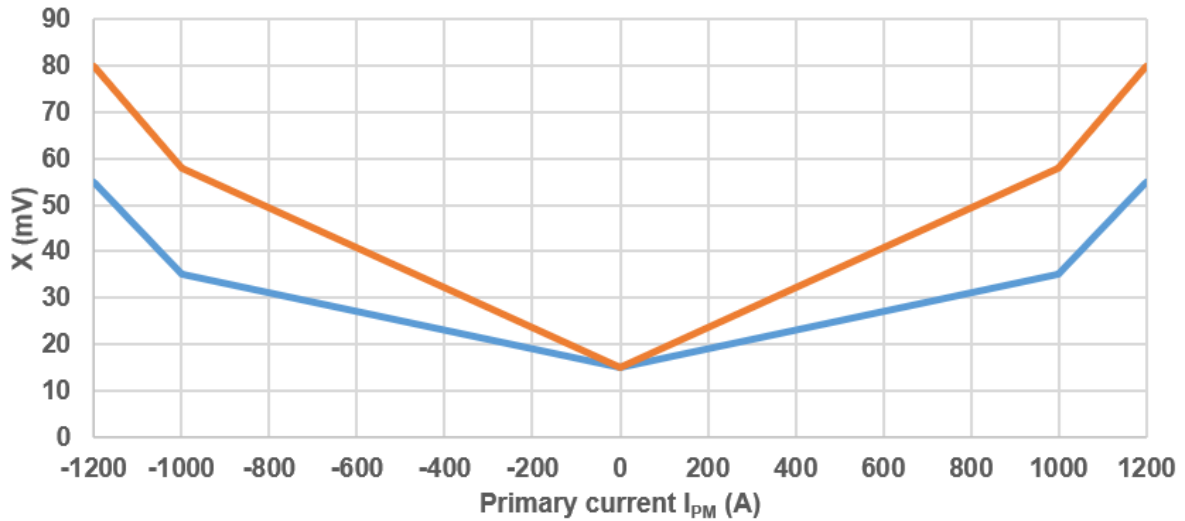

— Total error @ 25 °C(A) — Total error @ Trance (A)

Overall accuracy X specification(mV)		
$I_{PM}(A)$	@ $T_a = 25^{\circ}C, V_{CC} = 5.0V$	@ $-40^{\circ}C \leq T_a \leq 125^{\circ}C, V_{CC} = 5.0V$
1200	55	80
1100	44	68
1000	35	58
900	33	54
800	31	50
0	15	15
-800	31	50
-900	33	54
-1000	35	58
-1100	44	68
-1200	55	80

3. Dimension & Pin definitions

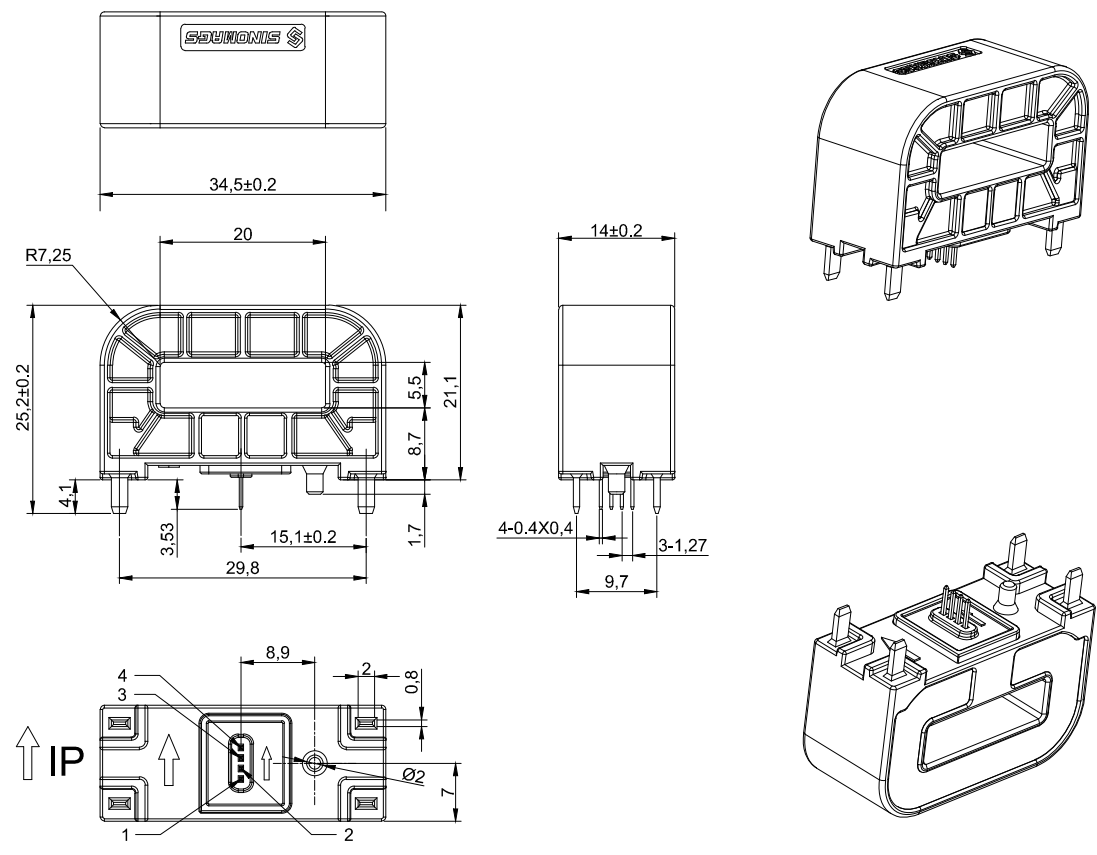

Material : Fit UL94V-0 & RoHS requirements ;
 General tolerance : ± 0.5
 Unit :mm

Terminals:

Pin1	GND
Pin2	GND
Pin3	Vout
Pin4	Vcc

