

Current Sensor

Product Series: STK-600/M-M

STK-600/M-050AB5-M, STK-600/M-100AB5-M

STK-600/M-150AB5-M, STK-600/M-200AB5-M

STK-600/M-250AB5-M, STK-600/M-050AB3-M

STK-600/M-100AB3-M, STK-600/M-150AB3-M

STK-600/M-200AB3-M, STK-600/M-250AB3-M

Part number: STK-600/M-200AC3-M, STK-600/M-250AC3-M

STK-600/M-050AU5-M, STK-600/M-100AU5-M

STK-600/M-150AU5-M, STK-600/M-200AU5-M

STK-600/M-250AU5-M, STK-600/M-050AU3-M

STK-600/M-100AU3-M, STK-600/M-150AU3-M

STK-600/M-200AU3-M, STK-600/M-250AU3-M

Version: Ver 2.0

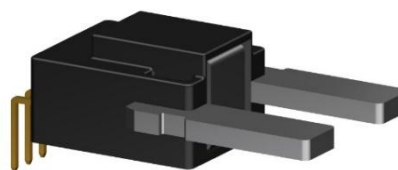
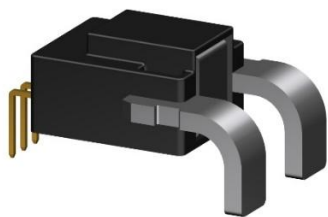

CONTENT

1.	Introduction	2
2.	Package: 5-pin package	2
3.	Features and Benefits	3
4.	Product Information	3
5.	Electrical Data	4
6.	Response Time	9
7.	Frequency Bandwidth	9
8.	Dimension & Pin Definitions	10

1. Introduction

The STK-600/M series current sensor is based on TMR (tunnel magnetoresistance) technology, and it has an open-loop design. It is suitable for DC, AC pulsed and any kind of irregular current measurement under the isolated conditions.

Typical applications

- AC Variable speed drives
- Motor driver
- Electric welder power supply
- BMS

General parameter

Parameter	Symbol	Unit	Value
Working temperature	T _A	°C	-40 ~ 125
Storage temperature	T _{stg}	°C	-40 ~ 125
Mass	m	g	4

Absolute maximum rating

Parameter	Symbol	Unit	Value
Supply voltage (not-destructive)	V _{CC}	V	6
ESD rating (HBM)	U _{ESD}	kV	4

Remark: the unrecoverable damage may occur when the product works on the conditions over the absolute maximum ratings. Long-time working on the absolute maximum ratings may cause the degradation on performance and reliability.

Isolation parameter

Parameter	Symbol	Unit	Value	Comment
RMS voltage for AC test 50Hz/1 min	U _d	kV	4	
Clearance distance (pri. -sec)	d _{Cl}	mm	8	Shortest distance through air
Creepage distance (pri. -sec)	d _{Cp}	mm	8	Shortest path along device body
Case material			V0 according to UL 94	

2. Package: 5-pin package

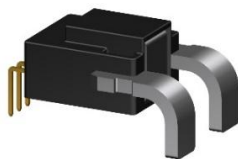

MPFF Leadform

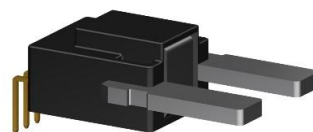

MPSF Leadform

3. Features and Benefits

UL certified, File No. E507664.

4. Product Information

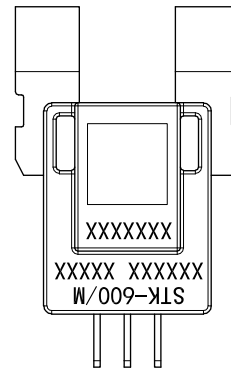
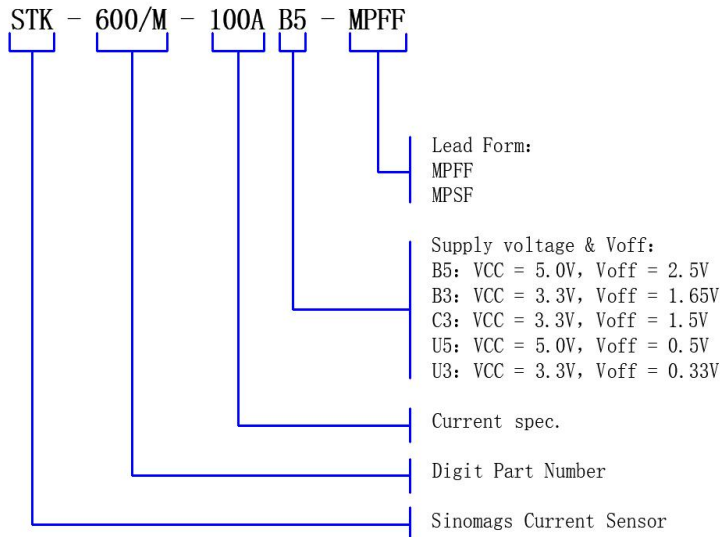

Production information is printed on the package surface by laser marking.

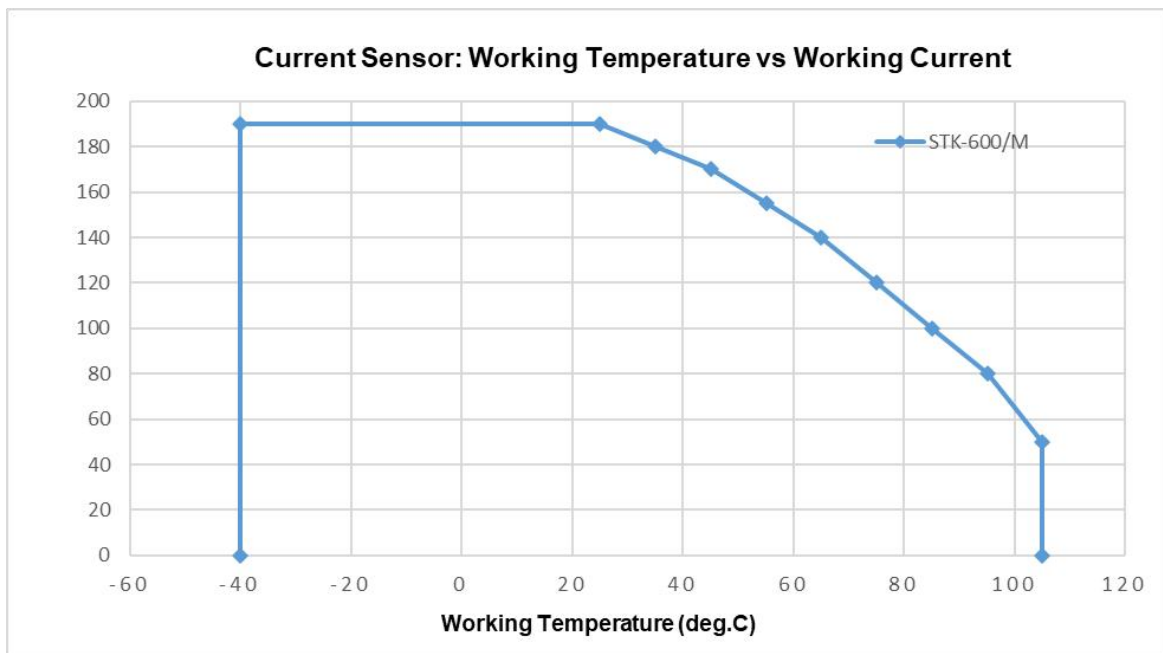

The relationship between working temperature & working current. It is suggested that the temperature of sensor not exceed 105 deg.C for better accuracy.

5. Electrical Data

 Condition: $T_A = 25^{\circ}\text{C}$, $V_{CC} = 5\text{V}$, STK-600/M-XXXAB5-M

Parameter	Symbol	Unit	Min	Typ	Max	Comment
Primary nominal current	I_{PN}	A		50		STK-600/M-050AB5-M
				100		others
Current range (refer remark)	I_{PM}	A	-50		50	STK-600/M-050AB5-M
			-100		100	STK-600/M-100AB5-M
			-150		150	STK-600/M-150AB5-M
			-200		200	STK-600/M-200AB5-M
			-250		250	STK-600/M-250AB5-M
Sensitivity	Sens	mV/ A	38.6	40	41.4	STK-600/M-050AB5-M
			19.3	20	20.7	STK-600/M-100AB5-M
			12.86	13.33	13.8	STK-600/M-150AB5-M
			9.65	10	10.35	STK-600/M-200AB5-M
			7.72	8	8.28	STK-600/M-250AB5-M
Supply voltage	V_{CC}	V		$5 \pm 5\%$		All
Power up Delay	T_{delay}	ms		80	120	All
Current consumption	I_{CC}	mA		6		All
Quiescent voltage $V_{out} @ 0\text{A}$	V_{off}	V	2.48	2.5	2.52	STK-600/M-XXXAB5-M
Peak output voltage ($V_{out} @ \pm I_{PM}$) - V_{off}	V_{FS}	V		± 2		STK-600/M-XXXAB5-M
Internal output resistance	R_{out}	Ω		22		All
Rated linearity error	E_{LIN}	% I_{PN}		± 1		$\pm I_{PN}$
Step response time @90% of I_{PM}	t_{res}	μs		4.6		STK-600/M-XXXAB5-M
Frequency bandwidth (-3dB)	BW	kHz		120		STK-600/M-XXXAB5-M
Output voltage noise DC ~ 10 kHz DC ~ 100 kHz	V_{noise}	mVp p		20 30		All
Accuracy @ 25°C	E_{TOT}	% of I_{PM}	-2.4	± 1	2.4	All
Accuracy @ $-40^{\circ}\text{C} \sim 105^{\circ}\text{C}$	E_{TOT}	% of I_{PM}	-3.5		3.5	All

 Condition: $T_A = 25^{\circ}\text{C}$, $V_{CC} = 3.3\text{V}$, STK-600/M-XXXAB3-M

Parameter	Symbol	Unit	Min	Typ	Max	Comment
Primary nominal current	I _{PN}	A		50		STK-600/M-050AB3-M
				100		others
Current range (refer remark)	I _{PM}	A	-50		50	STK-600/M-050AB5-M
			-100		100	STK-600/M-100AB3-M
			-150		150	STK-600/M-150AB3-M
			-200		200	STK-600/M-200AB3-M
			-250		250	STK-600/M-250AB3-M
Sensitivity	Sens	mV/ A	25.47	26.4	27.32	STK-600/M-050AB3-M
			12.74	13.2	13.66	STK-600/M-100AB3-M
			8.49	8.8	9.11	STK-600/M-150AB3-M
			6.37	6.6	6.83	STK-600/M-200AB3-M
			5.09	5.28	5.46	STK-600/M-250AB3-M
Supply voltage	V _{cc}	V		3.3 ± 5%		All
Power up Delay	T _{delay}	ms		80	120	All
Current consumption	I _{cc}	mA		6		All
Quiescent voltage V _{out} @ 0 A	V _{off}	V	1.63	1.65	1.67	STK-600/M-XXXAB3-M
Peak output voltage (V _{out} @ ±I _{pm}) –V _{off}	V _{FS}	V		± 1.32		STK-600/M-XXXAB3-M
Internal output resistance	R _{out}	Ω		22		All
Rated linearity error	E _{LIN}	% I _{PN}		± 1		± I _{PN}
Step response time @90% of I _{PM}	t _{res}	μs		4.6		STK-600/M-XXXAB3-M
Frequency bandwidth (-3dB)	BW	kHz		120		STK-600/M-XXXAB3-M
Output voltage noise DC ~ 10 kHz DC ~ 100 kHz	V _{noise}	mVp p		20 30		All
Accuracy @ 25°C	E _{TOT}	% of I _{PM}	-2.4	±1	2.4	All
Accuracy @ -40°C ~ 105°C	E _{TOT}	% of I _{PM}	-3.5		3.5	All

 Condition: T_A = 25°C, V_{CC}=3.3V, STK-600/M-XXXAC3-M

Parameter	Symbol	Unit	Min	Typ	Max	Comment
Primary nominal current	I_{PN}	A		100		All
Current range (refer remark)	I_{PM}	A	-200		200	STK-600/M-200AC3-M
			-250		250	STK-600/M-250AC3-M
Sensitivity	Sens	mV/	5.79	6	6.21	STK-600/M-200AC3-M
		A	7.72	4.8	8.28	STK-600/M-250AC3-M
Supply voltage	Vcc	V		3.3 ± 5%		All
Power up Delay	T_delay	ms		80	120	All
Current consumption	Icc	mA		6		All
Quiescent voltage Vout @ 0 A	Voff	V	1.48	1.5	1.52	STK-600/M-XXXAC3-M
Peak output voltage (Vout @ ±I _{pm}) –Voff	V_FS	V		± 1.2		STK-600/M-XXXAC3-M
Internal output resistance	R_out	Ω		22		All
Rated linearity error	E _{LIN}	% I _{PN}		± 1		± I _{PN}
Step response time @90% of I _{PM}	t_res	μs		4.6		STK-600/M-XXXAC3-M
Frequency bandwidth (-3dB)	BW	kHz		120		STK-600/M-XXXAC3-M
Output voltage noise DC ~ 10 kHz DC ~ 100 kHz	Vnoise	mVp p		20		All
				30		
Accuracy @ 25°C	E _{TOT}	% of I _{PM}	-2.4	±1	2.4	All
Accuracy @ -40°C ~ 105°C	E _{TOT}	% of I _{PM}	-3.5		3.5	All

Condition: T_A = 25°C, VCC=5V, STK-600/M-XXXAU5-M

Parameter	Symbol	Unit	Min	Typ	Max	Comment
Primary nominal current	I _{PN}	A		50		STK-600/M-050AU5-M
				100		others
Current range (refer remark)	I _{PM}	A	0		50	STK-600/M-050AU5-M
			0		100	STK-600/M-100AU5-M
			0		150	STK-600/M-150AU5-M
			0		200	STK-600/M-200AU5-M
			0		250	STK-600/M-250AU5-M
Sensitivity	Sens	mV/ A	77.2	80	82.8	STK-600/M-050AU5-M
			38.6	40	41.4	STK-600/M-100AU5-M
			25.73	26.66	27.59	STK-600/M-150AU5-M
			19.3	20	20.7	STK-600/M-200AU5-M
			15.44	16	16.56	STK-600/M-250AU5-M
Supply voltage	V _{cc}	V		5 ± 5%		All
Power up Delay	T _{delay}	ms		80	120	All
Current consumption	I _{cc}	mA		6		All
Quiescent voltage V _{out} @ 0 A	V _{off}	V	0.48	0.5	0.52	STK-600/M-XXXAU5-M
Peak output voltage (V _{out} @ ±I _{pm}) -V _{off}	V _{FS}	V		4		STK-600/M-XXXAU5-M
Internal output resistance	R _{out}	Ω		22		All
Rated linearity error	E _{LIN}	% I _{PN}		± 1		± I _{PN}
Step response time @90% of I _{PM}	t _{res}	μs		4.6		STK-600/M-XXXAU5-M
Frequency bandwidth (-3dB)	BW	kHz		120		STK-600/M-XXXAU5-M
Output voltage noise DC ~ 10 kHz DC ~ 100 kHz	V _{noise}	mVp p		20 30		All
Accuracy @ 25°C	E _{TOT}	% of I _{PM}	-2.4	±1	2.4	All
Accuracy @ -40°C ~ 105°C	E _{TOT}	% of I _{PM}	-3.5		3.5	All

 Condition: T_A = 25°C, V_{CC} = 3.3V, STK-600/M-XXXAU3-M

Parameter	Symbol	Unit	Min	Typ	Max	Comment
-----------	--------	------	-----	-----	-----	---------

Primary nominal current	I _{PN}	A		50		STK-600/M-050AU3-M
				100		others
Current range (refer remark)	I _{PM}	A	0		50	STK-600/M-050AU3-M
			0		100	STK-600/M-100AU3-M
			0		150	STK-600/M-150AU3-M
			0		200	STK-600/M-200AU3-M
			0		250	STK-600/M-250AU3-M
Sensitivity	Sens	mV/ A	50.95	52.8	54.65	STK-600/M-050AU3-M
			25.48	26.4	27.35	STK-600/M-100AU3-M
			16.98	17.6	18.22	STK-600/M-150AU3-M
			12.74	13.2	13.66	STK-600/M-200AU3-M
			10.19	10.56	10.93	STK-600/M-250AU3-M
Supply voltage	V _{cc}	V		3.3 ± 5%		All
Power up Delay	T _{delay}	ms		80	120	All
Current consumption	I _{cc}	mA		6		All
Quiescent voltage V _{out} @ 0 A	V _{off}	V	0.31	0.33	0.35	STK-600/M-XXXAU3-M
Peak output voltage (V _{out} @ ±I _{pm}) –V _{off}	V _{FS}	V		2.64		STK-600/M-XXXAU3-M
Internal output resistance	R _{out}	Ω		22		All
Rated linearity error	E _{LIN}	% I _{PN}		± 1		± I _{PN}
Step response time @90% of I _{PM}	t _{res}	μs		4.6		STK-600/M-XXXAU3-M
Frequency bandwidth (-3dB)	BW	kHz		120		STK-600/M-XXXAU3-M
Output voltage noise DC ~ 10 kHz DC ~ 100 kHz	V _{noise}	mVp p		20 30		All
Accuracy @ 25°C	E _{TOT}	% of I _{PM}	-2.4	±1	2.4	All
Accuracy @ -40°C ~ 105°C	E _{TOT}	% of I _{PM}	-3.5		3.5	All

6. Response Time

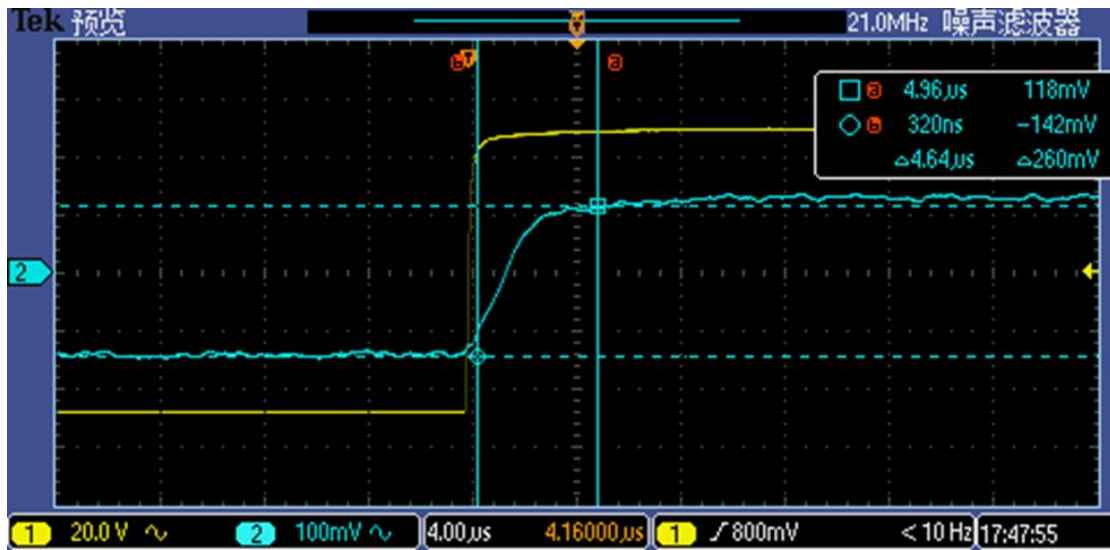

STK-600/M response time

7. Frequency Bandwidth

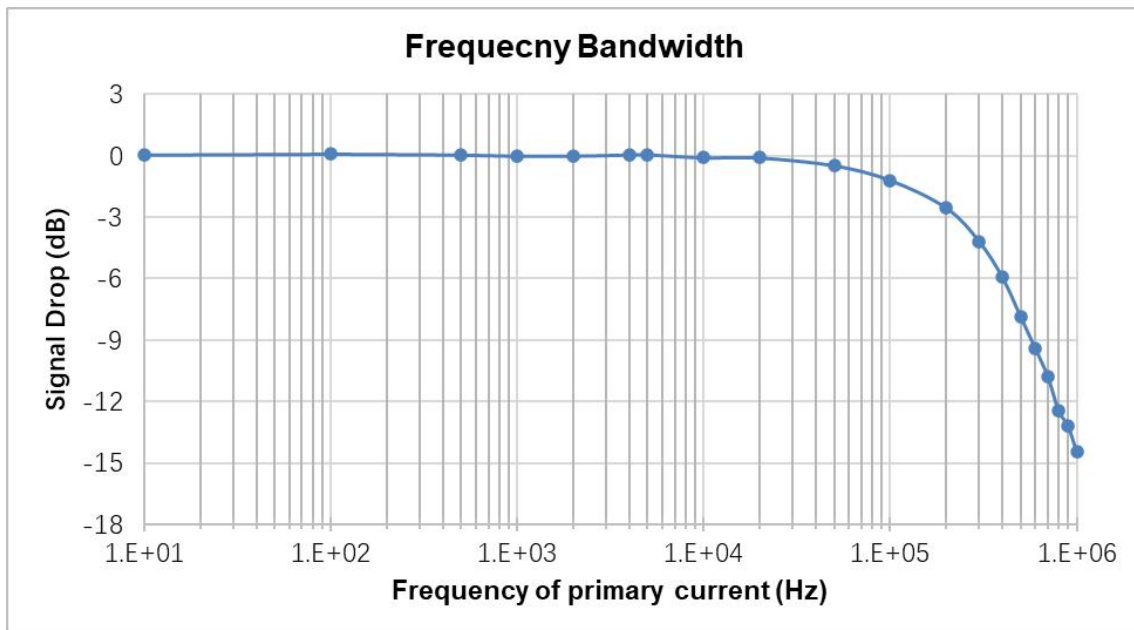

STK-600/M bandwidth

8. Dimension & Pin Definitions

Package, Leadform MPFF

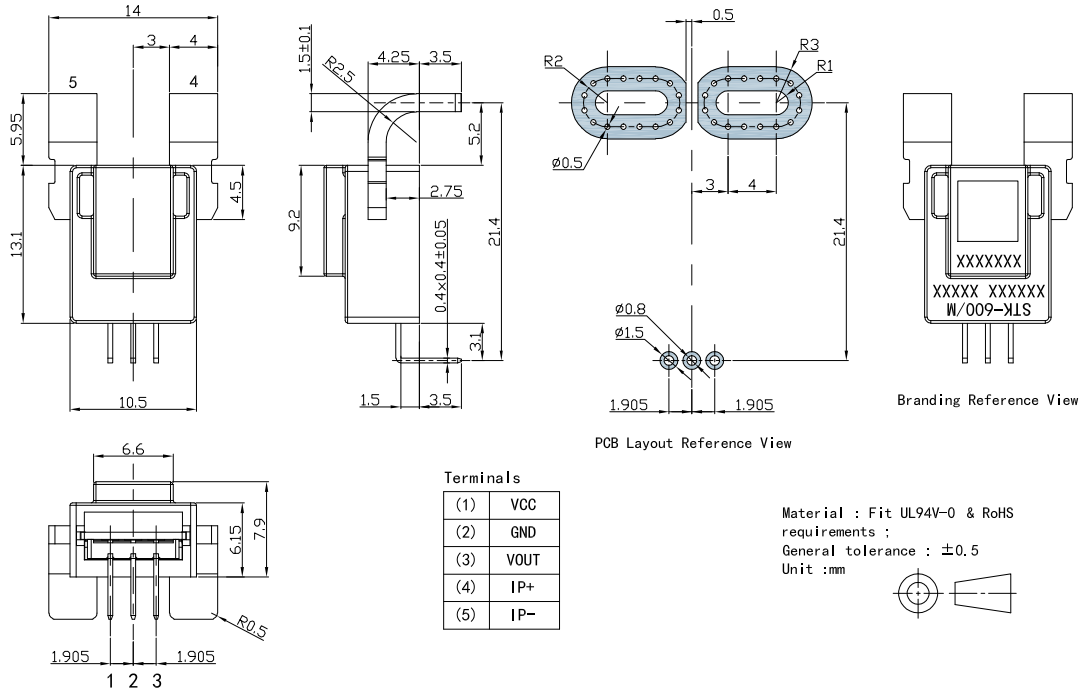

Package, Leadform MPSF

